

Nr. 22

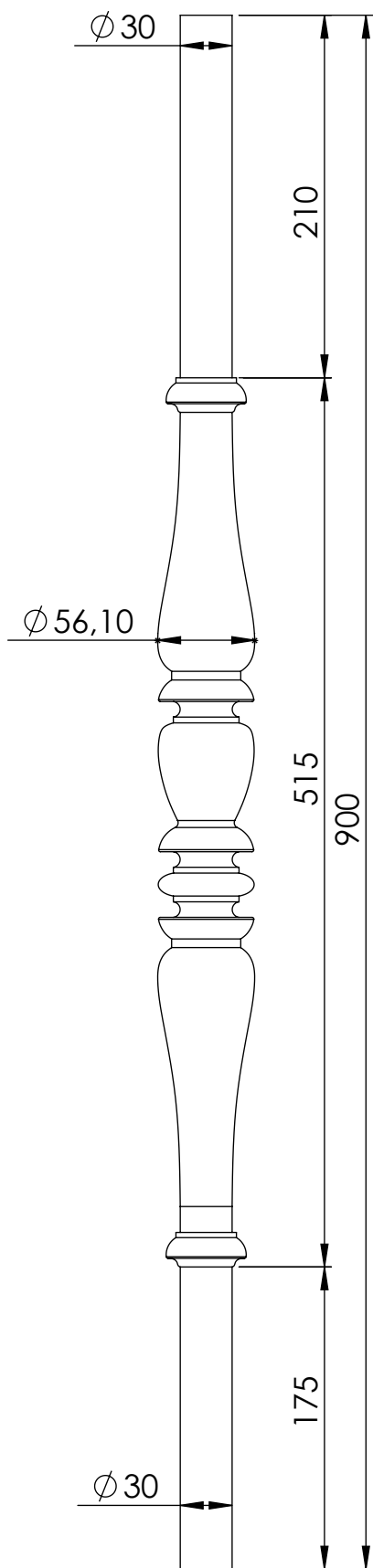

Nr. 22